

Air sampler TOPAS



The air sampler TOPAS is used for the sampling of air born particles:

- Suction and filtration of air born particles
- Encapsulated version, spray water tight (IP54)
- Connecting thread G 1 ½" (male)
- Exhausting thread G 1" (female)
- With quantometer and air flow meter
- Operation programmable up to 100 h or continuously mode
- Sound level only 62 dB(A)
- 230 VAC / 1ph. / 50 Hz / 0.4 kW
- Delivery with test protocol (incl. air flow rate)
- Incl. 5 m cable and dust hood
- Filter holders must be ordered separately (see accessories)
- Sampling rate:

Diameter 100 mm:	450 l/min. (Cellulose)	
	450 l/min. (Glass fibres)	
Diameter 105 mm:	460 l/min. (Cellulose),	460 l/min. (Glass fibres)
Diameter 200 mm:	620 l/min. (Cellulose),	620 l/min. (Glass fibres)
	417 l/min. (Charcoal)	
- Option:
 - Version with frequency converter for adjusting the air flow rate.
 - Version with volume preselection for automatic switch-off after reaching the preset collection volume
 - Version with operating hours counter on request



460 l/min. (Glass fibres)
 620 l/min. (Glass fibres)

Item number	Description	
114837	Air sampler TOPAS , with timer	
115170	Air sampler TOPAS , with timer, with frequency converter	
115960	Air sampler TOPAS , with timer, with volume preselection	
116376	Air sampler TOPAS , with timer, with frequency converter and with volume preselection	

Options:		
on request	Air sampler with Operating hours counter (115431) must be specified when ordering the particle sampler TOPAS	
Accessories:		
103481	Impeller anemometer for measuring the air flow rate. (Suitable to thread ring no. 101099, see below)	
115979	Calibration certificate for anemometer	
divers	Divers filter papers according to product info 05199 (search term on website)	
116175	Testing Quantometer , is connected upstream in order to be able to control the built-in quantometer	

Overview Filter diameter system: 105 mm (100 mm) 200 mm

Filtering directly on the device

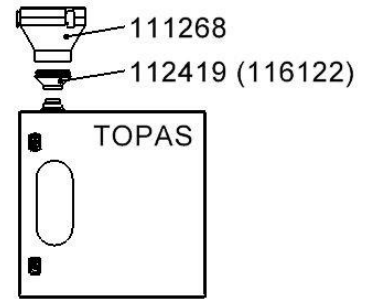
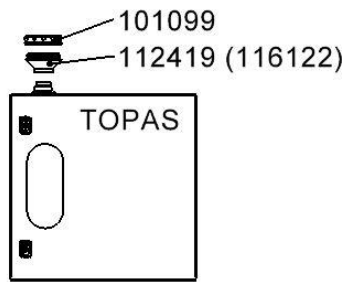

Filtering directly on the device with suction hose

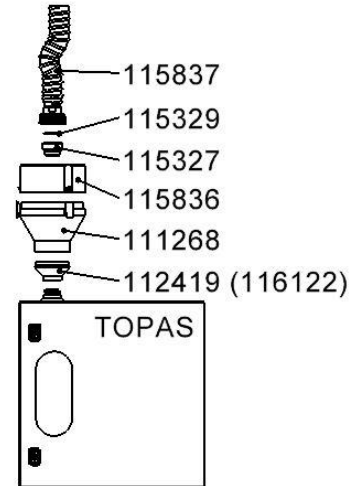
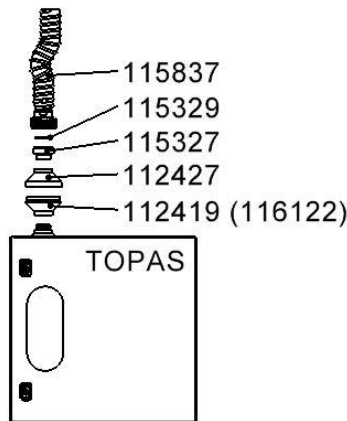

Filtering on site with suction hose

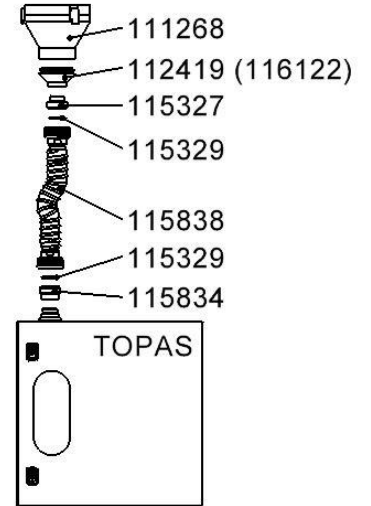
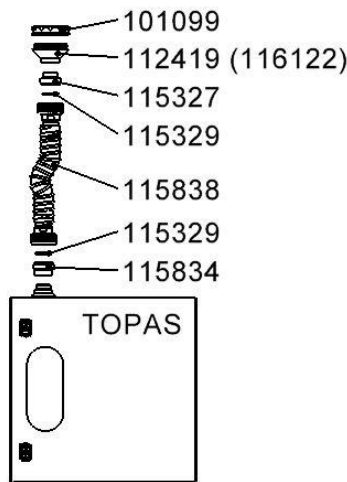

Accessories for 105 mm (100 mm) filtering		Accessories for 200 mm filtering	
116122	Holder paper 100 mm	116122	Holder paper 100 mm
112419	Holder paper 105 mm	112419	Holder paper 105 mm
101099	Threaded ring for filter cone 105 mm	111268	Holder paper 200 mm
112427	Filter cone 105 mm top	115836	Collection cover for 1 hose
115327	Screw-in part AG 1 ½" AG 2 ¼"	115327	Screw-in part AG 1 ½" AG 2 ¼"
115329	O-ring ø 47 x 5.34 mm	115329	O-ring ø 47 x 5.34 mm
115837	Spiral hose set I L = 10 m	115837	Spiral hose set I L = 10 m
115834	Screw-in part IG 1 ½" AG 2 ¼"	115834	Screw-in part IG 1 ½" AG 2 ¼"
115838	Spiral hose set II L = 10 m	115838	Spiral hose set II L = 10 m